

HAMMARLUND

SHORT WAVE MANUAL

DISTRIBUTED
BY
THE RADIO SHACK CORP.
46 BRATTLE ST., BOSTON

TEN CENTS
THE COPY

1938 EDITION

DISTRIBUTED
BY
THE RADIO SHACK CORP.
46 BRATTLE ST., BOSTON

The
Hammarlund 1938
Short Wave Manual

-
FOURTH EDITION

DEVOTED TO THE
AMATEUR
EXPERIMENTER
AND
SHORT WAVE
LISTENER

PUBLISHED BY
BY

THE HAMMARLUND MANUFACTURING CO., Inc.
424-438 West 33rd Street, New York, N. Y.

Edition fully Copyrighted 1958, Hammarlund Mfg. Co., Inc. Printed in U.S.A.

Introduction

THE art of short waves has become the greatest of all hobbies. Old as well as young, find enjoyment in listening to stations located in remote parts of the earth.

There are hundreds of short wave stations in operation, and they are providing no end of thrill for the short wave

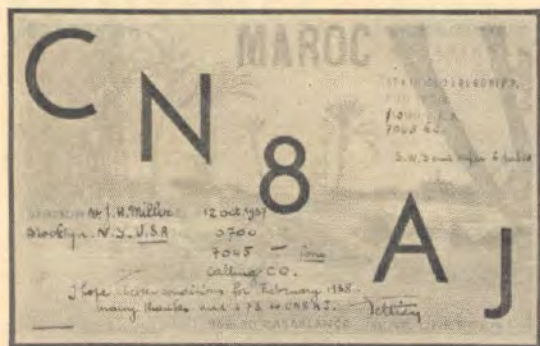

Short wave listeners make a hobby of collecting these QSL cards.

fan. While some of these stations are using very powerful transmitting apparatus, and can be received almost daily, others are using low power and are difficult to receive. These low powered "DX" stations provide greatest enjoyment. Almost any type of receiver will pick up the stronger stations so long as it is tuned to their frequency. Of course, these stations provide plenty of entertainment, such as, news of their native countries, and musical renditions such as operas and plays that have to do with their particular mode of living. Also political talks are given which tend to broaden one's knowledge of international affairs.

The weaker stations are entertaining, not so much from the program standpoint, but from the fact that it takes a good man at the controls, and a well-designed receiver using precision parts to pull them in. Then, there are other factors such as atmospheric conditions, time of day or night,

and the particular part of the sun-spot cycle during which reception is attempted.

Just receiving these stations and listening to their programs is not the only source of entertainment. Many short wave fans collect verification cards which are sent out by the stations. If you wish to collect cards of this nature, merely make a note of the time of day, date, station call letters, and type of program received. Also add other notes such as will be of interest to the station's operators, and help them to carry on their commendable task of providing world-wide entertainment. These details, together with an international reply coupon, should be mailed to the station. The coupon can be obtained from your local post office for \$.09 each. While nearly all of the short wave stations send out verification cards, there are a few who do not. Most notable among the latter are those operated by the British post office. Do not expect a "veri", as they are sometimes called, from the British or "G" stations.

The receivers described in this book are those most prominently found in use by short wave fans and amateurs. They are all of the simple regenerative type. These receivers are easy to build, easy to get going and easy to operate. As pointed out before, the success of these



A rare catch from Manila.

receivers lies in the use of the best parts and careful operation, together with an effective antenna system. The technique of operating a short wave receiver can only be developed by experience. The operator must get the "feel" of the receiver, learn just what each control does and just how a slight adjustment will affect reception of the weaker stations. The most critical control of this type of receiver is the regeneration control. This must be carefully adjusted for not only greatest sensitivity, but for a compromise between low background noise, loudest signal and elimination of interference from other stations. In the operation of a short wave receiver, as in all other arts, practice makes perfect.

In order to provide a wide selection of popular short wave receivers, we have contacted the editors of various prominent short wave magazines. Through correspondence with their readers, they have been able to recommend the types of receivers commonly used by the short wave fan, experimenter, and also by the new-comer.

These receivers have all been built in our laboratory and carefully designed to give the utmost of performance with a minimum of difficulty.

We have also included a two-page list of short wave stations. The station list editors of all popular magazines submitted a list of what they have found to



OSL from QX2QY in the Arctic.

be the most important and most consistently heard stations. From these lists we have compiled the condensed list shown. While all of the stations now operating are not listed, this list will serve as a guide; complete monthly lists appear in nearly every worthwhile short wave magazine. We recommend the use of such lists because they include the



Commander MacGregor and his ship.

many changes, as pertaining to operating schedules, that are made from time to time by the stations to facilitate reception.

Aside from regular short wave commercial stations, there are thousands of amateur stations operating daily. These "Ham" stations, as they are commonly called, do not broadcast music or other popular types of programs, but are important to the short wave listener who is after "DX". These amateur stations, as a rule, employ low power transmitters and many of them provide good "catches" for the "DX" fan. Also, their varied conversations provide no end of amusing entertainment.

The latter part of this book is devoted to the amateur and contains time-proven circuits of simple transmitters. The new-comer to amateur radio will find these transmitters easy to construct and very efficient in operation. Originally the transmitters were designed by the headquarters staff of the ARRL and described in the amateurs' official magazine, Q.S.T. However, they have been reconstructed and thoroughly tested in the Hammarlund laboratories, thus doubly assuring the builder that he will be more than repaid for his efforts in constructing them.

S-W STATION LIST

(Eastern Standard Time)

MC	CALL	
21.530	GSJ	DAVENTRY, ENG., 13.93 m., 5.45-8.55 am.
21.470	GSH	DAVENTRY, ENG., 13.97 m., 5.45 am-12 n.
17.790	GSG	DAVENTRY, ENG., 16.86 m., 3.15-5.30 am, 5.45 am-12n, 12.20-3.45 pm.
15.310	GSP	DAVENTRY, ENG., 19.6 m., 1.45-3.45 pm.
15.200	DJB	BERLIN, GERMANY, 19.74 m., 12.05-11 am. Also Sun. 11.10 am to 12.25 pm.
15.140	GSF	DAVENTRY, ENG., 19.82 m., 5.45 am-12 n.
15.110	DJL	BERLIN, GERMANY, 19.85 m., 12 m-2, 8-9 am, 1.40 am to 4.30 pm. Sun. also 6-8 am.
11.840	OLR4A	PRAGUE, CZECHOSLOVAKIA, 25.35 m., Daily 2-2.15 pm.
11.810	2RO	ROME, ITALY, 25.4 m., Daily 5-8.30 am, 10.30 am-12.20 pm.
11.800	JZJ	TOKIO, JAPAN, 25.42 m.
11.790	COGF	MATANZAS, CUBA, 25.45 m., relays CMGF 2-3, 4-5, 6-11 pm.
11.770	DJD	BERLIN, GERMANY, 25.49 m., 10.40 am-4.30 pm., 4.50-11 pm.
11.760	TGWA	GUATEMALA CITY, GUAT., 25.51 m., Tues. and Thurs. 8 pm-12 m.
11.750	GSD	DAVENTRY, ENG., 25.53 m., 3.15-5.30, 8.55 am-12 n, 12.20-6.00 pm., 9.15-11.15 pm.
11.720	CJRX	WINNIPEG, CANADA, 25.6 m., 4-10 pm.
11.715	TPA-4	PARIS, FRANCE, 25.61 m., 6.15-8.15 pm., 10 pm-1 am.
11.700	HP5A	PANAMA CITY, PAN., 25.65 m., 10 am-10 pm.
11.435	COCX	HAVANA, CUBA, 26.21 m., 6.55 am-1 am., Sun. till 12 m, relays CMX.
9.740	COCQ	HAVANA, CUBA, 30.78 m., 6.55 am-1 am, Sun. till 12 m.
9.680	FZF6	FORT de FRANCE, MARTINIQUE, 30.97 m., 11.30 am-12.30 pm, 6.15-7.50 pm.
9.660	LRX	BUENOS AIRES, ARG., 31.06 m., 8.30 am-10.30 pm.
9.635	2RO	ROME, ITALY, 31.13 m., Daily 12.30-9 pm.
9.630	HJ7ABD	BUCARAMANCA, COL., 31.14 m., 10 am-12 n, 4-11 pm.
9.615		KLIPHEUVAL, SOUTH AFRICA, 31.22 m., Daily exc. Sat. 11.45 pm-12.40 am, Daily exc. Sun. 3.20-7.15, 9-11.40 am, Sun. 4.5-3.0, 8-11.40 am.
9.600	RAN	MOSCOW, U.S.S.R., 31.25 m., Daily 7-9.15 pm.
9.590	VK2ME	SYDNEY, AUSTRALIA, 31.38 m., Sun. 1-3 am, 5-11 am.
9.580	GSC	DAVENTRY, ENG., 31.32 m., 4.15-6, 6.20-8.30, 9.15-11.15 pm.
9.580	VLR	MELBOURNE, AUSTRALIA, 31.32 m., Daily 3.30-8.30 am (Sat. till 9 am), Sun. 3-7.30 am. Daily exc. Sat. 9.35 pm-2.15 am.
9.550	OLR3A	PRAGUE, CZECHOSLOVAKIA, 31.41 m., Daily exc. Sun. 9.25-10.10 am., Daily 12.55-4.40 pm., Sun. 6.15-8.55 pm., Mon., Wed., Fri. 8-10.35 pm.
9.520	OZF	SKAMLEBOAEK, DENMARK, 31.51 m., 2-6.40 pm.
9.510	VK3ME	MELBOURNE, AUSTRALIA, 31.55 m., Daily except Sun. 4-7 am.
9.510	GSB	DAVENTRY, ENGLAND, 31.55 m., 3.15-5.30 am., 12.20-6 pm, 6.20-8.30, 9-11 pm.

MC	CALL	
9.505	HJIABE	CARTAGENA, COLOMBIA, 31.57 m., 5-10.30 pm.
9.500	XEWX	MEXICO CITY, MEX., 31.58 m., relays XEW, 6 pm-12 m.
9.478	EAR	MADRID, SPAIN, 31.65 m., 7.30-9.30 pm.
9.428	COCH	HAVANA, CUBA, 31.8 m., 7 am-1 am.
9.200	COBX	HAVANA, CUBA, 32.59 m., relays CMBX, 7 am-12 m.
9.090	COBC	HAVANA, CUBA, 32.98 m., relays CMBC, 6.55 am-12.30 am.
9.030	COBZ	HAVANA, CUBA, 32.2 m., 7.45 am-12.10 am. Irreg. 12.30-2 am. Relays CMBZ.
7.520	RKI	MOSCOW, U.S.S.R., 39.87 m., relays RAN 7-9.15 pm. Works RIM early am.
6.630	HIT	CIUDAD TRUJILLO, D.R., 45.25 m., Daily exc. Sun. 12.10-1.40 pm, 5.40-8.40 pm; also Sat. 10.40 pm-12.40 am.
6.558	HI4D	CIUDAD TRUJILLO, D.R., 45.74 m., exc. Sun. 11.55 am-1.40 pm.
6.316	HIZ	CIUDAD TRUJILLO, D.R., 47.5 m., Daily exc. Sat. and Sun. 11.10 am-2.25 pm, 5.10-8.40 pm, Sat. 5.10-11.10 pm, Sun. 11.40 am-1.40 pm.
6.243	HIN	CIUDAD TRUJILLO, D.R., 48 m., 12 m-2 pm, 7.30-9.30 pm, irregularly.
6.235	HRD	LA CEIBA, HONDURAS, 48.12 m., 8-11 pm, Sat. 8 pm-1 am, Sun. 4-6 pm.
6.150	CJRO	WINNIPEG, MAN., CANADA, 48.78 m., 4-10 pm.
6.140	W8XK	PITTSBURGH, PA., 48.86 m., relays KDKA 10 pm-1 am.
6.135	HJIABB	BARRANQUILLA, COL., 48.9 m., 11.30 am-1 pm, 4.30-10 pm.
6.130	COCD	HAVANA, CUBA, 48.94 m., relays CMCD 7 am-1 am.
6.130	VE9HX	HALIFAX, N.S., CAN., 48.94 m., Mon.-Fri. 9 am-1 pm; 5-11 pm, Fri.; 1-3 pm Sat.; Sun. 9 am-1 pm, 2-11 pm. Relays CHNS.
6.110	GSL	DAVENTRY, ENGLAND, 49.1 m., 6.20-8.30, 9.15-11.15.
6.100	W3XAL	BOUND BROOK, N. J., 49.18 m., 9.15 pm-1 am.
6.100	W9XF	CHICAGO, ILL., 49.18 m., 8 am-9.10 pm, 1.05-2 am.
6.090	CRCX	TORONTO, CANADA, 49.26 m., Daily 5.30-11.30 pm; Sun. 5-11.30 pm.
6.070	CFRX	TORONTO, CANADA, 49.42 m., relays CFRB 6.30 am-11 pm; Sun. 9.30 am-11 pm.
6.060	W8XAL	CINCINNATI, OHIO, 49.6 m., relays WLW 6.30 am-8 pm, 11 pm-2 am.
6.060	W3XAU	PHILADELPHIA, PA., 49.5 m., relays WCAU 8-11 pm.
6.040	WIXAL	BOSTON, MASS., 49.65 m., exc. Sat. 7-9 pm.
6.030	OLR2B	PRAGUE, CZECHOSLOVAKIA, 49.75 m.
6.020	DJC	BERLIN, GERMANY, 49.83 m., 10.40 am-4.30, 4.50-10.45 pm.
6.010	COCO	HAVANA, CUBA, 49.92 m., Daily 7.55 am-12 m; Sun. till 11 pm.
6.005	HP5K	COLON, PAN., 49.96 m., 7-9 am, 11.30 am-1 pm, 6-11 pm.
6.005	CFCX	MONTREAL, CANADA, 49.96 m., relays CFCF, 7.45 am-1 am. Sun. 10 am-12.15 am.
5.850	YV1RB	MARACAIBO, VEN., 51.28 m., 8.45-9.45 am, 11.15 am-12.15 pm; 4.45-9.45 pm; Sun. 11.45 am-12.45 pm.
5.800	YV5RC	CARACAS, VEN., 51.72 m., Sun. 8.30 am-10.30 pm; Daily 7-8 am, 10.30 am-1.45 pm, 3.45-9.30 pm.
4.836	HJ3ABD	BOGOTA, COL., 62 m., 12 m-2 pm, 7-11 pm; Sun. 5-9 pm.

One Tube Battery Set for Beginner

This one-tube battery operated receiver is intended for the beginner. It is advisable to start with a one-tube set because of its simplicity of construction. Many budding short wave enthusiasts have become discouraged for the simple reason that the first set was entirely too complicated. This receiver, while employing only one tube, will provide no end of entertainment insofar as short wave code and phone reception are concerned. The type of construction employed deserves careful consideration. Many beginners start with the so-called bread-board model and usually end up with considerable grief. We strongly recommend that the chassis and panel method be employed in all types of receiver. The use of metal panels and chassis provides excellent shielding, permits much more effective common or ground circuits, and eliminates nearly all body capacity effects.

It is true that more efficient multi-tube receivers can be constructed with tubes intended for operation from a power pack. But the simple one and two-tubers that the beginner builds

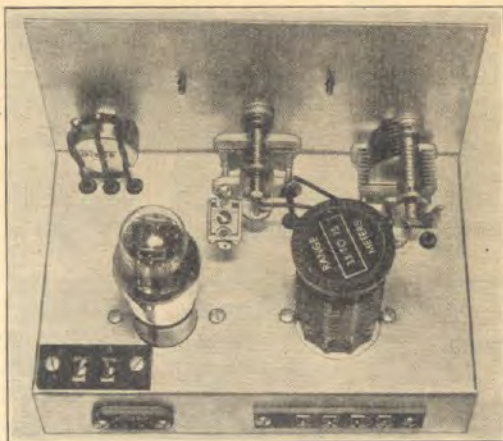

This view clearly shows the arrangement of parts for the one-tube battery set.

usually employ batteries for the simple reason that the complication of power supply construction, together with the hum troubles that may be encountered, are eliminated. The tube employed in this receiver consumes a very small amount of power and therefore batteries can be economically used. The tube, a 1E7-G, is a twin pentode. That is, there are two sets of elements contained in the single glass envelope. In the circuit employed in this receiver the tube actually functions as two separate pentodes. One section is employed as a regenerative detector while the other serves as a resistance coupled audio amplifier. There are many other tubes of the battery type which might have been selected for this receiver. However, this one provides the best performance. Standard Hammarlund plug-in coils are employed to cover a range of from 17 to 270 meters. These coils are tuned with two condensers. One is an "MC-140-M" and serves as a band setting condenser. Connected in parallel with this condenser is an "MC-20-S" which is used for band-spread tuning. For maximum efficiency, band spread tuning is absolutely necessary in any short wave receiver. The antenna is coupled directly to the grid side of the tuned circuit with an "MEX" padding condenser which serves as an antenna trimmer. Regeneration is controlled with a 50,000 ohm potentiometer connected in the screen grid circuit.

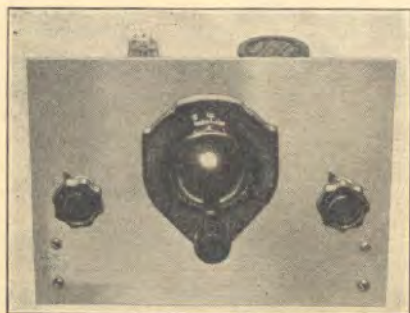

Panel layout showing the placement of controls.

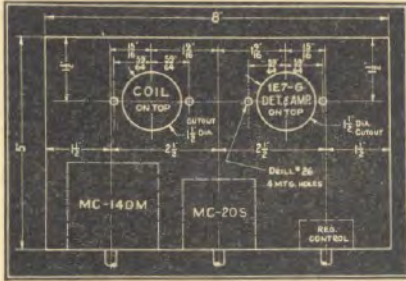

Drilling specifications for the chassis.

Complete drilling details are given in the drawing. After the chassis has been prepared and the parts have been mounted, wiring is the next step. Employ a good grade of "push-back" wire and carefully solder all connections. All connections that go to the common B-minus, or chassis, are connected to a soldering lug placed underneath the nearest screw. All leads and connections should be as short and direct as possible.

There are four power terminals on the receiver—two for the "A" battery, and two for the "B" battery. Since no rheostat is mounted in the receiver, an external resistor must be employed. This is indicated as "R" in the A-plus filament lead. The reason for this resistor is that the receiver requires two dry cells connected in series which provide three volts and the tube only requires two volts. We suggest that a 10-ohm variable resistor be employed in the position marked "R". This control can be mounted on the panel and should be adjusted so that the receiver performs properly. However, use care not to turn the rheostat on too far and thus damage the tube. A volt meter connected across the filament terminals of the tube will aid

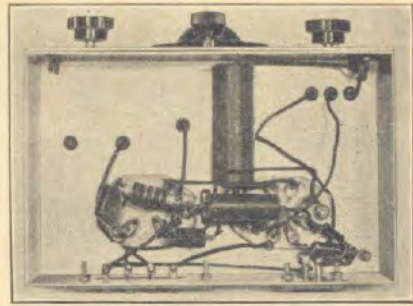

Bottom view showing wiring, condensers, and resistors.

Parts List

HAMMARLUND

- 1—MC-20-S Band spread cond.
- 1—MC-140-M Band setting cond.
- 1—MEX antenna trimmer
- 1—CHX 2.1 mh. R.F. choke
- 1—S-4 4-prong socket
- 1—S-8 8-prong socket
- 1—SWK-17-270 meter plug in coil set

CORNELL DUBILIER

- 1—.006 mf. mica cond.
- 1—100 mmf. mica cond.
- 2—300 mmf. mica cond.
- 1—.1 mf. paper cond.
- 1—1 mf. paper cond.

I. R. C.

- 1—3 meg.-1/2 watt resistor
- 1—1/4 meg.-1/2 watt resistor
- 1—50,000-1/2 watt resistor
- 1—50,000 ohm potentiometer

MISC.

- 1—Chassis, 8 x 5 x 2"
- 1—Panel 8 x 6 x 1/16" (alum.)
- 1—Twin terminal strip
- 1—Phone strip
- 1—4 lug terminal strip

adjustment. Naturally, it should read two volts for proper operation.

Best results were obtained with 90 volts applied to both the screen and the plate. However, some tubes may require less screen voltage. We suggest that the experimenter first try 45 and then 90. Tuning hints and suggestions will be found in the introductory part of this manual.

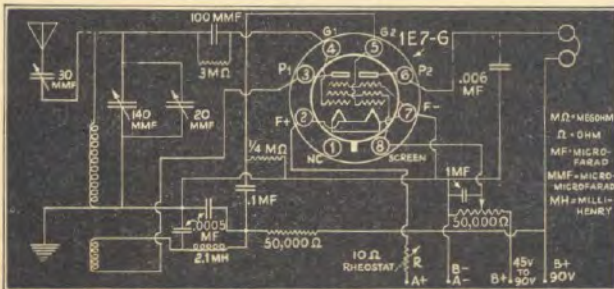

Wiring diagram and parts values.

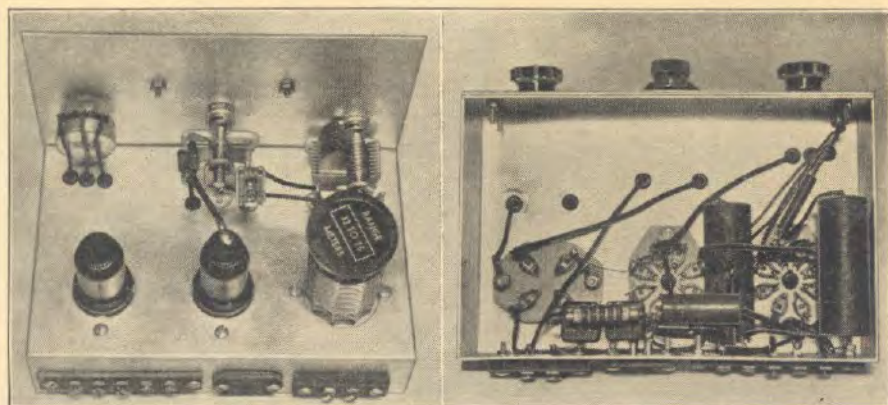

Rear and bottom views showing placement of parts and wiring.

The "Metal Tube Two"

THE "Metal Tube-Two" receiver is for the more advanced short wave experimenter. Two of the newer metal tubes are employed. One is a 6J7 regenerative detector and the other, a 6C5 triode, is a resistance coupled audio amplifier. This combination provides about the ultimate in simple short wave receivers. It is especially sensitive and will produce extremely loud signals. Loud enough, in fact, to operate a small speaker.

This receiver is designed to operate from the power supply described in another part of this book. Two-hundred-fifty volts are required for the B-supply and 6.3 volts A.C. for the heaters.

As in the one-tube set previously described, we also employ standard Hammarlund SWK plug-in coils in this one. In simple receivers the plug-in coil method is unquestionably the most satisfactory, because there is no danger of dead spots due to absorption caused by unused windings. Here too, we have also employed the band-spread system shown in the smaller set.

The tickler is connected in the plate circuit for obtaining regeneration. In the diagram, the tickler is shown at the top of the grid coil while actually it is wound at the bottom of the coil form. However, the connections remain identical. It is drawn at the top merely as a convenience. In order to eliminate feed

back in the audio stage, and to keep all traces of R.F. out of the grid circuit of the audio amplifier, a filter consisting of a 2.1 mh. R.F. choke and two .0005 mf. condensers, is employed in the B-plus side of the tickler circuit.

Regeneration is controlled by varying the voltage applied to the screen grid of the 6J7 regenerative pentode detector. The 50,000 ohm potentiometer and the 100,000 ohm resistor, are connected in series across the B-supply, that is, between the B-plus and B-negative, in order to obtain the correct voltage for the screen grid. The adjustment of this regeneration control is covered in the introductory part of the Manual and need not be discussed here.

The 30 mmf. trimmer, connected in series with the antenna, serves for varying the antenna coupling. Once set for the highest frequency coil, this condenser will need no further adjustment unless an extremely weak signal is encountered. Closing the condenser plates (increasing capacity), will increase the sensitivity and thus bring up the strength of the weak signal. However, as the capacity of this condenser is increased, the set automatically tunes broader. There is an optimum adjustment; one which provides sufficient signal strength without interference from stations transmitting on adjacent channels.

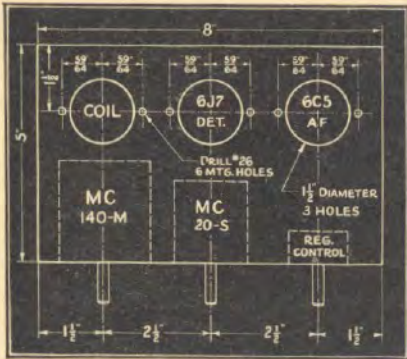

Drilling dimensions for chassis.

The diagram contains the circuit for an additional pentode power amplifier. This amplifier, when added to the main receiver will provide full speaker volume on all popular short wave stations. The .006 mf. condenser connected between the plate of the 6C5 and the B-minus should be connected between the plate of the 6F6 and B-minus when the additional audio stage is employed. The parts list does not contain the items employed in the additional amplifier. Also, the chassis on which the original receiver is built is not large enough for the second amplifier. We suggest a 10" chassis—one extending 2" farther to the right. The drilling of the 8" portion will, of course, remain the same. The panel should also be correspondingly larger.

This receiver has been found to operate best on an antenna from 40 to 75 feet long. Consisting of a single wire, the antenna should be mounted in the

clear and away from all trees, metal roofs, etc. A receiver is only as good as the antenna with which it is used. Use a good antenna system and you will be well repaid.

The beginning amateur will find this the ideal set with which to start. Even today thousands are in use by Hams.

Parts List

HAMMARLUND

- 1—MC-140-M Band setting cond.
- 1—MC-20-S Band-spread cond.
- 1—MEX antenna trimmer (30 mmf.)
- 1—CH-X r.f. choke
- 1—S-4 socket
- 2—S-8 sockets
- 1—SWK-4, 17 to 270 meter plug-in coil set

CORNELL DUBILIER

- 1—100 mmf. mica condenser
- 2—500 mmf. mica condensers
- 1—.006 mf. mica condenser
- 1—.1 mf. paper condenser
- 2—1 mf. paper condensers

I. R. C.

- 1—2 meg. 1/2 watt Resistors
- 2—1/4 meg. 1/2 watt Resistors
- 1—2,000 ohm 1 watt Resistor
- 1—100,000 ohm 1 watt Resistor
- 1—50,000 ohm potentiometer

MISC.

- 1—8 x 5 x 2" Chassis
- 1—8 x 6 x 1/16" Panel (aluminum)
- Terminal strips, screws, etc.
- 2—Knobs
- 1—Dial

R. C. A.

- 1—6J7 metal tube
- 1—6C5 metal tube

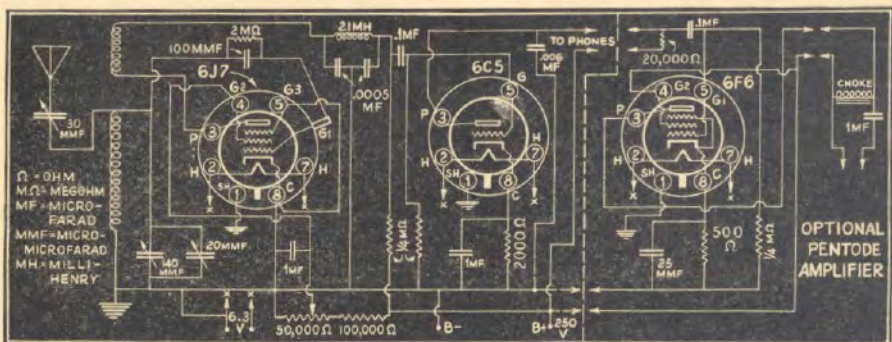

Wiring diagram with optional amplifier stage.

The Radio Amateur's Handbook

3-Tube Band- Spread A C Set

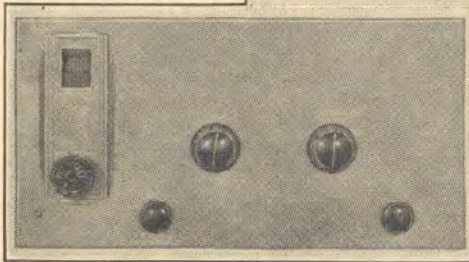
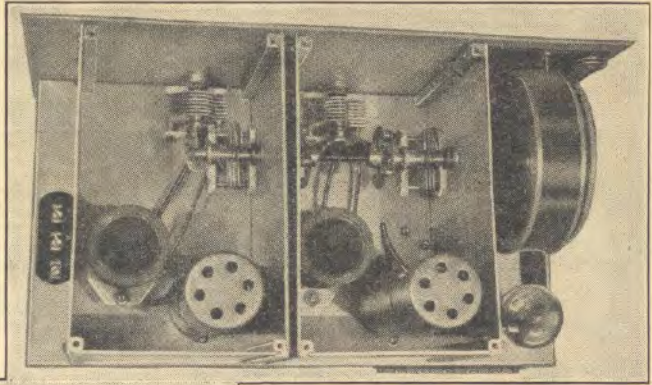

The receiver illustrated here represents a good example of such a set. It is a model constructed after the description which appeared in "The Radio Amateur's Handbook," tenth edition.

In the construction of this model there was some variation from the original, mainly in the method of obtaining regeneration. The original had the tickler in the cathode circuit and standard plug-in coils are not well suited to this arrangement. In the model described here, therefore, the circuit was changed to include the tickler in the plate circuit. No change was made in the method of controlling regeneration—a potentiometer to vary the voltage applied to the screen grid.

SOONER or later most owners of regenerative receivers feel the urge to try the use of radio-frequency amplification ahead of the regenerative detector. In the days when only triode tubes were available the complications in this were severe and at best very little amplification was obtained in the r.f. stage. With the introduction and popularization of screen-grid tubes and r.f. pentodes, however, the picture has changed completely with the result that a well designed r.f. stage adds tremendously to the sensitivity and general behavior of the regenerative receiver.

Referring to the schematic circuit of Figure 2, it will be seen that the r.f. stage is quite conventional in every respect. It employs a type -58 tube which is also self biased.

It is important that means for con-

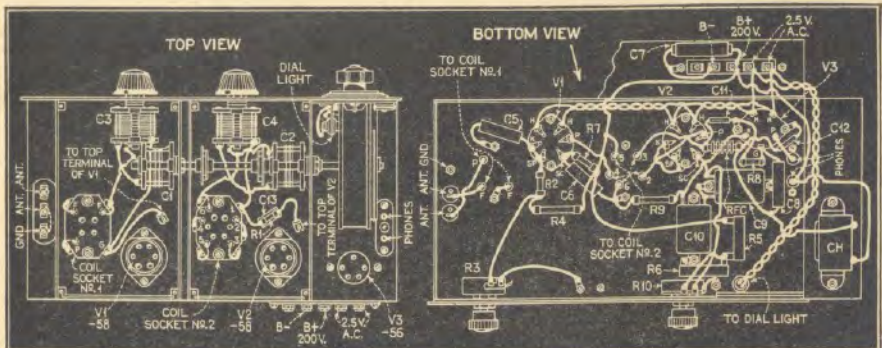

Fig. 1

trolling the gain of the r.f. stage be provided on the front panel of such a receiver as this. Otherwise even moderately strong signals will overload the detector. If the regeneration control alone were depended upon for this purpose the results would be highly unsatisfactory because in addition to detector overloading, there would be a distinct loss of selectivity when regeneration is retarded to reduce the volume. On the other hand, by controlling the gain of the r.f. stage, the input to the detector can be held down to a low level, full regeneration employed and thus maximum selectivity obtained.

The band-spread system employed provides continuous band-spreading by means of a small condenser shunted across the tank tuning condenser of each stage. These tank condensers are controlled by individual knobs. These may be seen as the two top control knobs in one of the accompanying photographs. The small band-spread condensers, however, are ganged for control by the single main tuning control at the left end of the receiver.

Not only does this system provide a very helpful degree of band spreading at any and all points throughout the range of the receiver, but it also provides single dial control within any band which has been selected by means of the tank condensers. Thus when the broadcast listener has tuned the tanks to resonance in the 25-meter broadcast band, for instance, he proceeds to tune in the individual stations in that band with the single main control, much in the same manner as he would tune in broadcast band stations on a modern broadcast receiver. The circuits will be found to track fairly well throughout the full rotation of the band spread dial, although some readjustment of the r.f. tank condenser will be required.

The model receiver shown here was built for use with Hammarlund standard plug-in coils and with the tuning capacities used, will cover the short-wave range from 19 to well over 200 meters, with adequate overlap, using 4 pairs of these coils.

The secret of using a tuned r.f. stage successfully, ahead of a regenerative detector, lies in providing thorough shielding. If shielding is inadequate there will be interaction between the two circuits to the extent that the tuning of one will react on the other and regeneration will be difficult to control.

This receiver is intended for operation from an a.c. power supply unit which will supply approximately 200 volts d.c. for the plates and $2\frac{1}{2}$ volts for the heaters. Should it be desired to employ

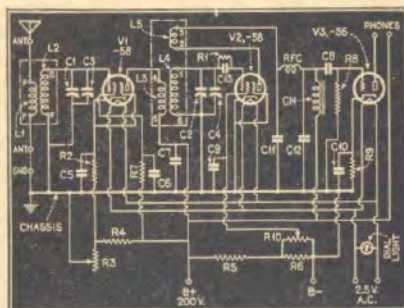

Fig. 2

B batteries, the voltage divider consisting of R5 and R6 may be eliminated and the "high" end of the potentiometer brought out to the 45-volt tap on the B battery.

The chassis is made from a sheet of 16-gauge aluminum, 17 inches by 11 inches. The edges are bent down 2 inches all around, making the deck dimensions 13 inches by 7 inches. The front panel is $13\frac{1}{2}$ inches long by 7 inches high. The shield cans each measure 7 inches long, $4\frac{3}{8}$ inches wide and $4\frac{3}{4}$ inches high.

Parts List HAMMARLUND PRODUCTS

- C1, C2—Midget variable condensers, type MC-20-S
- C3, C4—Midget variable condensers, type MC-140-M
- L1, L2—Kit of 4-prong plug-in coils, type SWK-4
- L3, L4, L5—Kit of 6-prong plug-in coils, type SWK-6
- RFC—R.F. choke, type CH-X
- 1 Isolantite socket, 4-prong, type S-4
- 1 Isolantite socket, 6-prong, type S-6
- 2 Tube shields, type TS-50
- 2 Flexible couplings, type FG

MISCELLANEOUS

- C5, C6, C8—Cornell-Dubilier .01 mfd., 200v.
- C7—Cornell-Dubilier .1 mfd., 400v.
- C9, C10—Cornell-Dubilier type HC-227 1.0 mfd., 160v.
- C11, C12, C13—Cornell-Dubilier .00025 mfd.
- CH—Thorndarson audio choke, type T-2927
- R1—I.R.C. resistor, 5 megohms
- R2—I.R.C. resistor, 250 ohms, 1 watt
- R3—Electrad potentiometer, 10,000 ohms
- R4—I.R.C. resistor, 50,000 ohms, 1 watt
- R5—Electrad wire wound resistor, 15,000 ohms, 5 watts
- R6—Electrad wire wound resistor, 5000 ohms, 5 watts
- R7—I.R.C. resistor, 100,000 ohms, $\frac{1}{2}$ watt
- R8—I.R.C. resistor, 5 megohms, $\frac{1}{2}$ watt
- R9—I.R.C. resistor, 2000 ohms, 1 watt
- R10—Yaxley potentiometer, 50,000 ohms
- 1 National illuminated drum dial, type H
- 2 Eby laminated wafer sockets, 6-prong
- 1 Eby laminated wafer socket, 6-prong
- 1 Eby strip, 5-gang (screw terminals)
- 1 Eby strip, 3-gang (screw terminals)
- 1 Eby strip, 2-gang (tip jack terminals)
- 1 Aluminum chassis and 2 aluminum shield cans (see text).

*All metalized type.

Front and rear views of the "Two Stage Pre-Selector." Ideal unit for reducing noise and images.

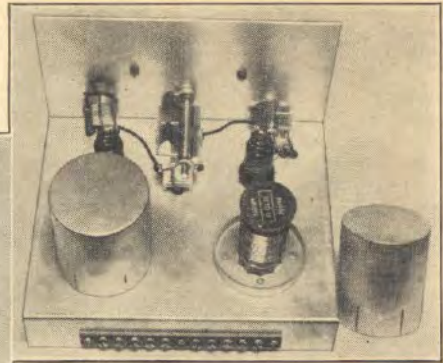
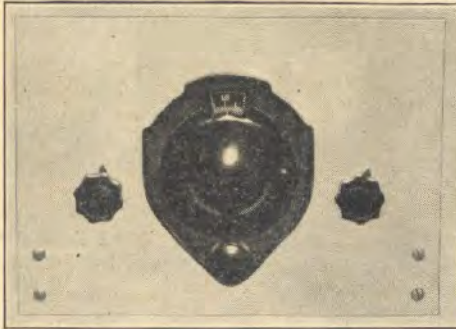

This unit will improve any superheterodyne

Two Stage Pre-Selector

The pre-selector is a worthwhile addition to any superheterodyne, particularly those not having too much sensitivity. This one, in particular, will work well with present superheterodynes having no R.F. ahead of the first detector. Even those already having one stage of R.F. can be improved by the use of this unit. Not only does it increase the sensitivity of your present superheterodyne, but it also goes a long way toward eliminating images—that is, two-spot tuning. Noise is also reduced somewhat due to the overall increase in sensitivity and selectivity of the receiver.

A power supply for operating this pre-amplifier is not included in the unit. Inasmuch as it is to be used with some sort of receiver, the power can be taken directly from the receiver power supply. From 180 to 250 volts are required for the plate supply and 6.3 volts for the heaters. If your present receiver employs 2.5 volt tubes, such as the 58's and 56's, then it will be necessary to employ two type 58 pentodes in place of the 6K7 metal tubes shown in the diagram. If the glass tubes are used, it is necessary to shield them in order to prevent feedback. In this regard, the metal tubes are superior because of their thorough shielding.

It will be noticed that the two plug-in coils, which are SWK-6, 3-winding Hammarlund coils, are shielded with Hammarlund "CS" coil shields. Do not

attempt to operate the amplifier without these shields because it just won't work. Also it will be noticed that the dual 140 mmf. condenser has a shield plate between the two stators. This must also be grounded in order to eliminate feedback.

Band spread is not employed for the simple reason that it is not necessary. R. F. stages tune rather broad as compared to the tuning control of the receiver. In the first R.F. stage—that is, the one nearest the antenna circuit, the interwound winding is employed for trimming. Here we have a 100 mmf. condenser connected across the winding with one side grounded. The grounded side is that nearest the grounded side of the larger winding. The small coil at

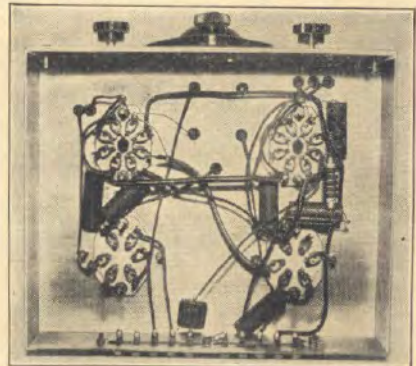

Bottom view showing the wiring.

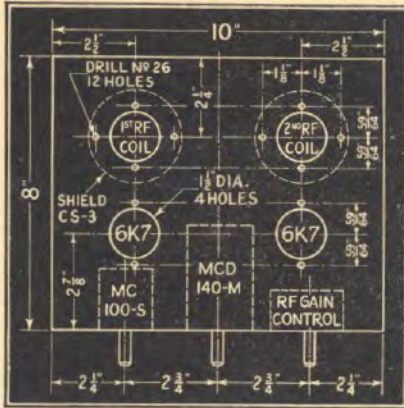

Drilling dimensions for the chassis.

the bottom of the form, usually termed the tickler, is used as the antenna coupling coil. This coil remains unused in the second stage. The interwound winding serves as the plate coupling coil and the large winding as the grid coil for the second amplifier tube. This also is tuned with a 140 mmf. condenser. With proper adjustment, of the 100 mmf. padding condenser, the two circuits will track very nicely.

There are many arrangements which can be used for coupling the pre-selector to the receiver proper. However, the arrangement shown is the simplest and is entirely satisfactory. Merely connect the output terminal of the converter to the antenna post of your receiver. The negative side of the converter need not be connected to the receiver because this connection is already made through the power supply. In wiring up the receiver, all leads should be short and direct.

Long leads in a high gain amplifier of this type will cause no end of trouble. The longest lead is the one going from the second coil to the plate of the first 6K7. It will be noticed that this lead is shielded in order to reduce feed back. Do not employ ordinary shielded wire. This lead should be made with hook-up wire having heavy insulation, and a short length of braided shielding material should be placed over the wire. If the capacity between the shielded wire is too great, considerable sensitivity will be lost. The converter has a volume control of its own which should be operated independent of the receiver. The correct setting for the volume control can only be learned by experience.

Parts List

HAMMARLUND

- 1—MCD-140-M two gang condenser
- 1—MC-100-M trimmer condenser
- 1—CHX R.F. choke
- 2—S-8 sockets
- 2—S-6 sockets
- 2—CS coil shields
- 2—SWK-6 6-prong coil sets 17-270 M.

CORNELL DUBILIER

(Condensers)

- 6—.1 mf. paper
- 1—500 mmf. mica

I. R. C.

(Resistors)

- 2—300 ohm 1/2 watt
- 2—100,000 ohm 1/2 watt
- 1—50,000 ohm 1 watt
- 1—10,000 ohm potentiometer

MISC.

- 1—8 x 10 x 2" chassis
- 1—7 x 10" panel (aluminum)
- 1—Dial
- 2—Knobs
- Binding post strips, screws, etc.

R. C. A.

- 2—6K7 Metal tubes

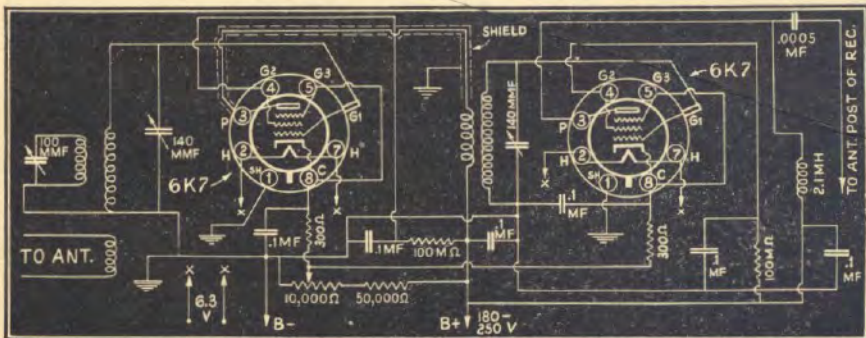

Wiring diagram and values of "Two Stage Pre-selector."

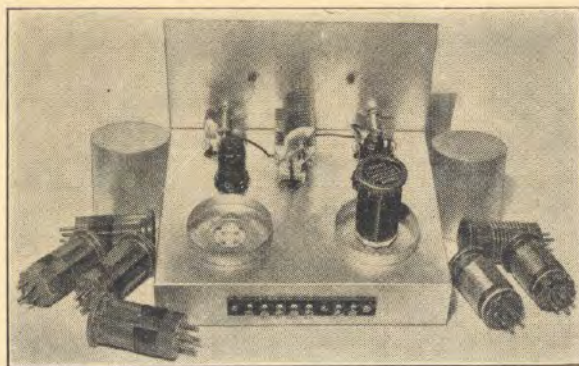

*Complete short
wave converter
with coils.*

SW-CONVERTER

WHILE many short wave fans have small one-tube and two-tube receivers and desire a more complicated set, many do not feel equal to the task of building it. If you have a good broadcast receiver, that is, one covering the regular broadcast band but not taking in the short wave bands, this simple two-tube converter will enable you to receive short wave stations on the regular home set at full speaker volume. A combination of the two provides a very effective all wave receiver capable of producing fine results. When combined with this converter, the broadcast receiver merely serves as the I.F. and A.F. amplifier unit having its own power supply. No tuning is done with the broadcast receiver. All adjustments, aside from volume control, are made on the converter. Referring to the wiring diagram, we find that we have a 6L7 pentagrid mixer which is used in conjunction with a 6C5 as high frequency oscillator. The two tubes work together to convert the incoming short wave signal into a frequency suitable for amplification by the broadcast set.

The large receiver is tuned near maximum wavelength, or lowest frequency, in the broadcast band. The exact position of tuning is governed by the broadcast stations in operation. The dial should be set so that no broadcast station comes through to interfere with the short wave signal.

The first coil, or the one in the 6L7 grid circuit, is a standard Hammarlund

SWK-4 coil set with a tuning range of from 17 to 270 meters. The oscillator coil, however, must be especially constructed with the following specifications. The highest frequency coil has 6 turns spaced to a total length of $\frac{3}{8}$ " ; the cathode cap is taken off at approximately 1 turn from the B-minus end of the circuit. The next largest coil has 12 turns spaced to a total length of $\frac{5}{8}$ " and the cathode tap is at $1\frac{1}{2}$ turns. The next coil has 27 turns spaced to a length of 1" with the cathode tap at the second turn. The largest coil has 45 turns close wound with the cathode tap at the 4th turn. Number 26 silk covered wire is used for all coils. The diagram shows a separate coil winding for the cathode circuit. If the coil data given above is employed, the cathode will be tapped

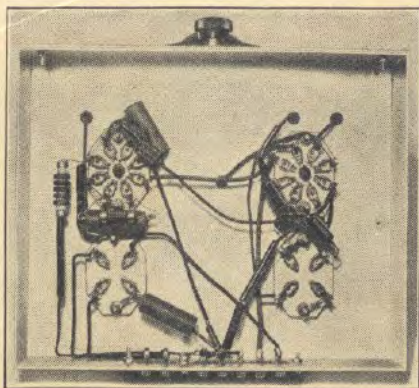

Bottom view showing wiring.

on to the large coil the number of turns specified from the B-minus side of the coil. If standard 4-prong Hammarlund coils are to be used in the oscillator, that is the same type as are used in the 6L7 circuit, then the diagram given would be followed. The small winding at the lower side of the coil will be used for the cathode circuit. This is normally the tickler. It will be necessary to reduce the number of turns until it equals the amount between the tap and the B-negative side of the coil in the specifications already given. The secondary or grid winding will also need modification. In all but the 17 to 41 meter coil, the number of grid turns must be reduced 20%. The 17 to 41 meter coil, requires greater spacing for the same number of turns. Merely increase the spacing slightly between the turns. With the above coil specifications, the two circuits should track fairly close.

Two sets of tuning condensers are employed. One is a two-gang "MCD-35-X" condenser and is the main tuning condenser employed for band spread. The two 100 mmf. condensers adjust the tuning range of the converter.

This converter also employs the receiver power supply described previously. It is not recommended that the power for the converter be taken from the broadcast receiver.

One connection of the converter connects the antenna post of the broadcast receiver. The B-minus lead of the converter should also connect to the ground terminal of the broadcast set. The antenna connections, a doublet being preferred, connect to the antenna coil in the 6L7 grid circuit.

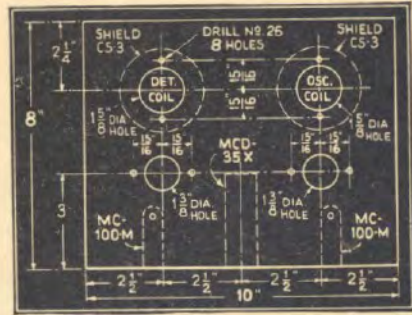

How to drill the chassis.

Parts List

HAMMARLUND

- 1—MCD-35-X condenser
- 2—MC-100-M condensers
- 2—S-3, 3-prong sockets
- 2—S-4, 4 prong sockets
- 2—CS-3 Coil shields
- 1—CHX R.F. choke
- 1—SWK-4, coil kit 17-270 meters
- 4—SWF-4, 4-prong coil forms

I. R. C.

(Resistors)

- 1—500 ohm 1/2 watt
- 1—.1 meg. 1/2 watt
- 2—100,000 ohm 1/2 watt
- 1—10,000 ohm 1 watt

CORNELL-DUBILIER

(Condensers)

- 3—.1 mf. tubular
- 1—.01 mf. tubular
- 2—100 mf. mica
- 1—.0005 mf. mica

R. C. A.

- 1—6L7 tube
- 1—6C5 tube

MISC.

- 2—Knobs
- 1—Dial
- 1—Chassis, 8" x 10" x 2"
- 1—Panel 7" x 10"—both 1/16" aluminum

Wiring diagram for two-tube short wave converter.

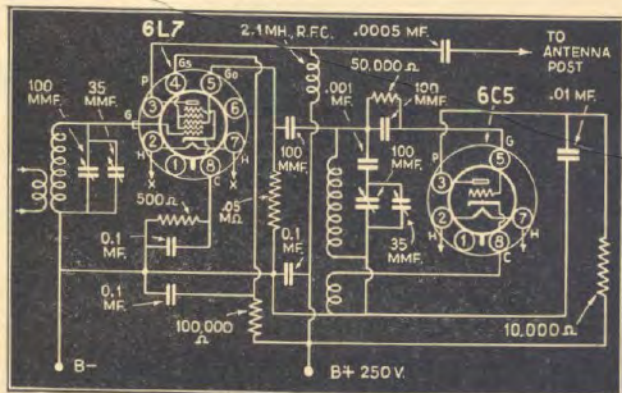

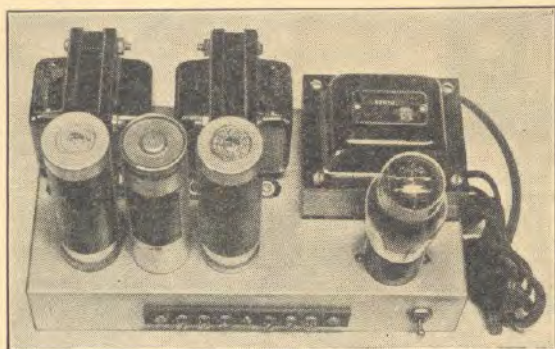

Two views showing the construction of the receiver power-supply.

Receiver Power- Supply

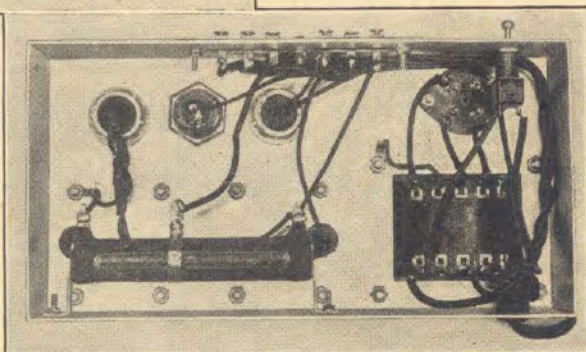

The several short wave receivers previously described require a separate power-supply. While the power-supply and the receiver may be incorporated in one unit, it is to the advantage of the experimenter to have the power-supply separate. This permits its use with other apparatus. This power-supply is constructed of good parts with ratings sufficient to work with the receivers in this book and still maintain a wide range of safety. If the experimenter desires to build larger receivers, that is, receivers having considerably more tubes than those illustrated in this book, it is advisable to use components of higher ratings. For instance, the power transformer in this particular power-supply, while delivering sufficient voltage at 70 milliamperes, will handle up to three or four tubes. In case larger receivers are to be used with it, we recommend that the transformer have a rating of at least 100 milliamperes. The filter choke coils of this power-supply are rated at 80 ma. These also should be increased to approximately 100 ma., if the larger sets are contemplated. No other values in the power supply need be changed in

order to increase its current capacity. Another point which should be considered is the type tubes which may at some time or other be used during experimenting. Our diagram shows a single 6.3 volt filament winding. If at any time you expect to employ $2\frac{1}{2}$ volt tubes in your receiver for some other experimental set-up, we suggest that the power-supply be equipped with a $2\frac{1}{2}$ volt winding as well as the 6.3 volt winding. Such transformers are readily available. For convenience, we have used a 5x8x2 inch chassis constructed of $1/16$ " aluminum. All four sides are bent down in order to make it rigid. On one of these sides is mounted the terminal strip containing the plate and filament connections. On the other side we have the on-off toggle switch. The placement of these items can be learned from the photograph.

The output voltage of the power-supply is very important. In this particular one, the output voltage is 300 under normal load. Choke input is employed. If condenser input were used, the voltage would be entirely too high. If condenser input is desired, for any particu-

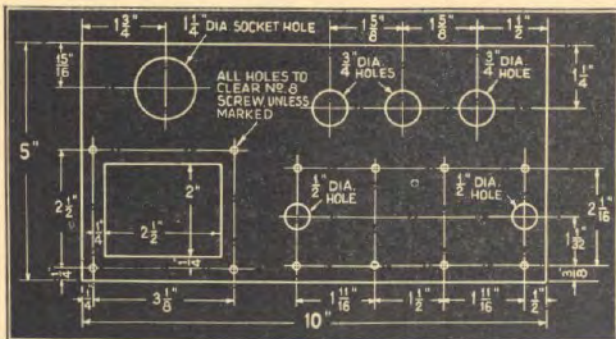

Drilling specifications for power-supply chassis.

lar reason, the high voltage rating of the secondary should be around 250 volts. The bleeder or voltage divider connected across the output terminals of the filter consists of a 20,000 ohm 50 watt resistor. As can be seen in the diagram, one tap is provided in case lower voltages are required. This tap should be adjusted under load with the aid of a volt meter in order to obtain proper voltage. If more than one intermediate voltage is required, additional taps may be placed on the voltage divider. However, bear in mind that the resistor shown is only rated at 50 watts and that there is an idle current of approximately 15 milliamperes already flowing through it with no load. This means that the total additional load which the resistor will stand is 35 ma. If greater current requirements are necessary a resistor with a higher rating should be employed. One of approximately 75 to 100 watts would serve, depending upon the current drawn. During tests, this power-supply in conjunction with the receivers previously illustrated, was what might be considered hum-free. If trouble is experienced due to tunable hums, that is hums appearing in some places on

the dial in the receiver and not in others, they may be eliminated by connecting .001 mf. condensers between each plate of the rectifier and one side of the filament. Juggling these connections may be necessary in order to completely eliminate tunable hums. Also, outside line noises can be reduced considerably by connecting a .1 mf. condenser between one side of the 110 volt primary and B-minus. Use a high grade 400 V. paper condenser.

Parts List

STANCOR

- 1—Power transformer—P 943
- 2—Filter chokes—C-1420

AEROVOX

- 3—8 mf. electrolytic condensers (500 V).

I. R. C.

- 1—20,000 ohm voltage divider with one slider

R. C. A.

- 1—Type 30 rectifier

MISC.

- 1—5" x 8" x 2" chassis (1/16" aluminum)
- 1—Toggle switch

Wiring diagram and parts values for power-supply.

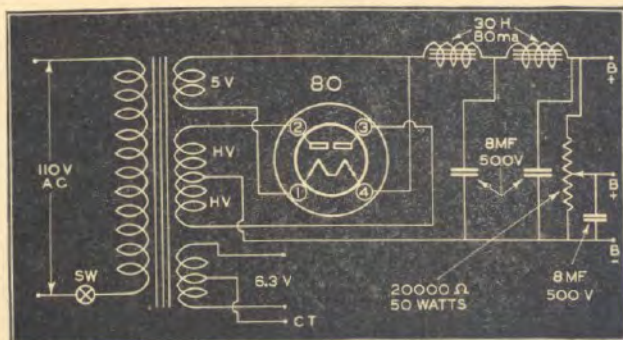

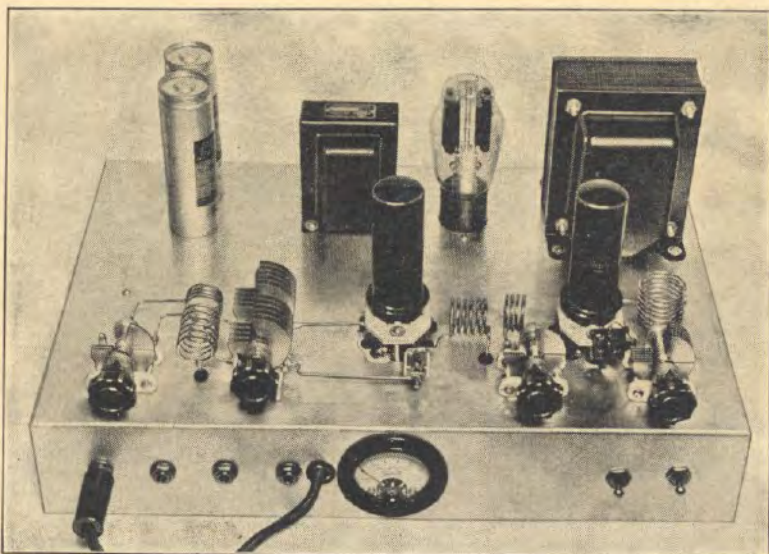

5-Meter Mopa

THE 5-meter amateur band has become extremely popular with the young ham. Nearly all newcomers start off with a 5-meter transmitter.

Since the introduction of the beam type power tubes, many amateurs have incorporated them in their ultra-high frequency apparatus. The 5-meter transmitter illustrated in the photograph was originally designed by W2AMN and described in *SHORT WAVE & TELEVISION* magazine. This transmitter provides a very steady and sharp signal which does not cause a lot of interference with other amateurs. Two type 6L6 tubes (metal type) are employed. One

as an electron coupled oscillator and the other as a 5-meter power amplifier. The oscillator grid circuit is tuned to 10 meters and the plate circuit is tuned to 5. Frequency doubling in this stage is employed in order to improve stability.

The amplifier is inductively coupled to the oscillator and the diagram shows a neutralizing condenser. However, this condenser is not needed if the amplifier is properly adjusted. The neutralizing circuit is shown for those who may desire to incorporate it in the transmitter. The entire transmitter, not including the modulator, is mounted on a 17" x 11" x 3" aluminum chassis. No drilling specifications are given. Reference to drawing clearly shows the placement of parts. A circuit diagram for a suitable modulator which will work well with this transmitter is given in one of the drawings. Commercial audio amplifiers having an output of around 15 watts work very satisfactory and in many cases are much cheaper to buy than build. A single meter is employed for measuring currents in the various circuits. Four jacks are provided along the left-hand edge of the chassis. These are single closed circuit jacks and are

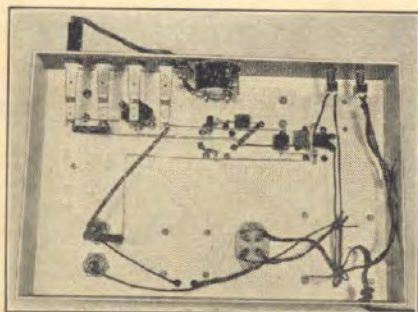

Bottom view of the 5-meter MOPA

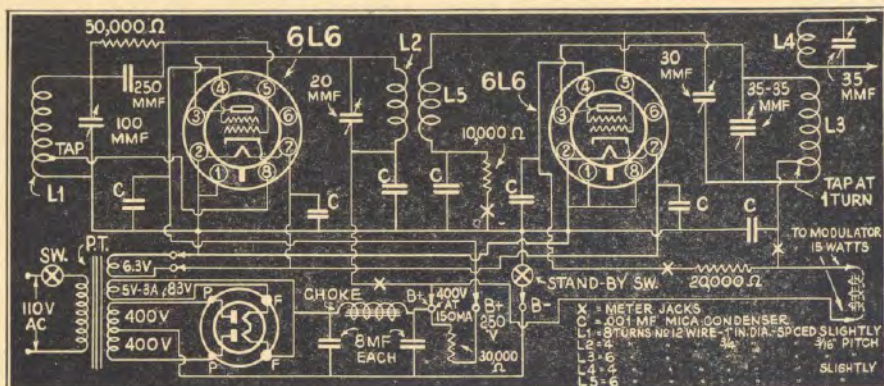

connected as shown in the diagram. On the right-hand edge of the chassis we have the standby switch. This opens the B-negative circuit, shutting the transmitter off during reception.

Tuning and adjusting the transmitter is simple if the following procedure is adhered to: With the amplifier tube removed from its socket, the oscillator grid condenser should be adjusted until a signal from the oscillator is picked up, in the proper portion of the band, on the receiver. Next, disconnect the B-plus from the amplifier tube by inserting a dummy plug in the proper jack and insert the amplifier tube. The meter plug should then be connected to indicate grid current of the amplifier. The plate circuit of the oscillator is then adjusted for maximum grid current as indicated by the meter. Next, insert the meter plug into the final amplifier plate jack, after removing the dummy plug, this will connect the B- to the amplifier.

Swing the amplifier plate condenser until plate current is at minimum. Then couple the antenna and adjust for a plate current of 75 milliamperes.

Parts List

HAMMARIUND

- 1—MC-100-S Condenser
- 1—MC-20-S Condenser
- 1—MC-35-S Condenser
- 1—MCD-35-X Condenser
- 1—MEX trimmer
- 2—S-B 3-prong Isolantite sockets
- 1—S-1 4-prong Isolantite socket

AEROVOX

- 6—.001 mf. mica receiving type condensers
- 1—.001 mf. mica 1,000 v.-lt condenser
- 2—8 mf. electrolytic-500 V condensers

I. R. C.

- 1—50,000 ohm 1 watt resistor
- 1—10,000 ohm 1 watt resistor
- 1—20,000 ohm 20 watt resistor
- 1—20,000 ohm 75 watt voltage divider

STANCOR

- 1—Plate and filament trans. No. P-3005
- 1—Filter choke, No. C-1421

R. C. A.

- 2—6L6 beam tubes
- 1—83V rectifier tube

TRIPLETT

- 1—0-100 ma. small meter

MISC.

- 4—Single closed circuit jacks
- 1—Phone plug, 1—Toggle switch
- 4—Knobs
- 1—Aluminum chassis 17"x11"x3"

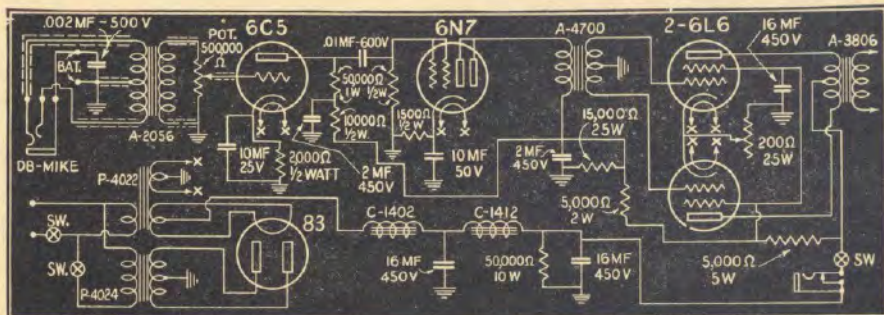

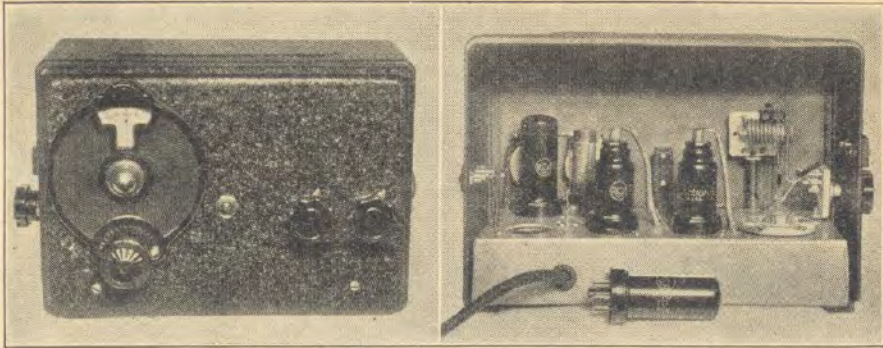

5-Meter Super-Het

ALTHOUGH this 5-meter receiver is intended for use with the 5-meter MOPA previously described, it can be used by the fan for receiving police calls and television signals. There are five tubes in a resistance coupled circuit. Four are metal tubes, while the fifth one is an "acorn" regenerative detector.

Resistance coupling is employed because of its low cost and simplicity of construction. The entire receiver is built in a Crowe metal can, measuring 10" x 5" x 6½".

Since this receiver is an autodyne superheterodyne, each station will appear in two spots on the dial, but very close together. The band width of the receiver is nearly 100 kc. and makes it possible to receive modulated oscillators as well as other types of signals having a slight amount of frequency modulation.

The quality, when a crystal controlled signal is being received, is very good because of the very wide band width. Excellent music and entertainment programs can be received from the ultra-high frequency television and experimental stations. During unusual atmospheric conditions, it is possible to receive stations thousands of miles distant with excellent quality.

In order to facilitate tuning and increase stability, automatic volume control is incorporated in the receiver. This is brought about by employing a 6F6 connected as a high- μ triode as the second detector. The automatic volume control voltage is obtained from the grid circuit at the center tap of the grid resistor and returned to the grids of the two 6K7 I.F. amplifiers. This automatic volume control arrangement is very effective and eliminates the necessity for an R.F. gain control.

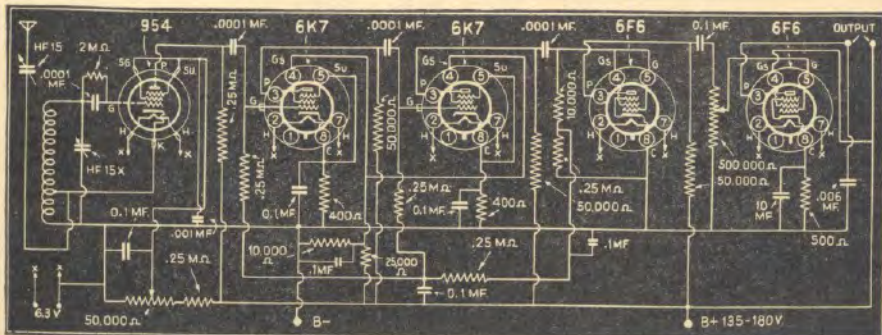

Wiring diagram of resistance coupled ultra-high frequency receiver.

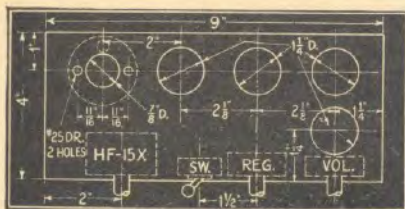

Drilling specifications.

All leads must be short and direct, and it is advisable to keep them well separated, especially the grid and plate leads. Although the diagram does not show it, the grid leads from the two 6K7's are shielded with copper braid. This braid covers the grid lead right from the grid cap to the point where it goes through the chassis. It is grounded at this point with a soldering lug placed under the nearest screw.

A 15 mmf. tuning condenser is employed. This is a Hammarlund "HF-15-X" and the coil has 10 turns of No. 12 tinned copper wire $\frac{3}{4}$ " in diameter and spaced to a length of $1\frac{1}{4}$ ". Although the 15 mmf. capacity is rather high, tuning it is not too critical. In order to adjust the range of the tuning circuit slightly, the coil turns may be spaced farther apart or squeezed together depending upon the desired results. Also, if just the 5 meter amateur band is to be covered, several plates may be removed from the "HF-15-X" tuning condenser. Adjustment of this part of the circuit will have to be done experimentally.

The receiver power supply described previously in this book works very nicely with the 5 meter super-het. However, any good power supply should give sat-

isfactory results, providing the maximum voltage is somewhere in the neighborhood of 180 volts. When putting the receiver into operation, turn the regeneration control all the way off and the audio volume control all the way on. Then advance the regeneration control until a slight hiss is heard. Outside interference such as crackling and buzzing noises will also be heard. Then rotate the tuning dial until the station is heard. Final adjustment of the antenna condenser and the regeneration control, as well as the tuning condenser, should bring it up to full speaker volume.

Parts List

HAMMARLUND

- 1—HF-15-X condenser
- 1—HF-15 condenser
- 1—S-900 acorn socket

I. R. C.

(Resistors)

- 5— $\frac{1}{4}$ meg. $\frac{1}{2}$ watt
- 1— $\frac{1}{4}$ meg. 1 watt
- 3—50,000 ohm $\frac{1}{2}$ watt
- 1—2 meg. $\frac{1}{2}$ watt
- 2—400 ohm $\frac{1}{2}$ watt
- 1—10,000 ohm $\frac{1}{2}$ watt
- 1—500 ohm 1 watt
- 1—10,000 ohm 1 watt
- 1—25,000 ohm 1 watt
- 1—50,000 ohm potentiometer
- 1—500,000 ohm potentiometer

CORNELL DUBILIER

(Condensers)

- 4—.0001 mf. mica
- 1—.001 mf. mica
- 1—.006 mf. mica
- 7—.1 mf. paper (tubular)
- 1—10 mf. electrolytic

R. C. A.

- 1—954 tube
- 2—6K7 tubes
- 2—6F6 tubes

MISC.

- 1—Crows box
- 1—National Dial
- 3—Knobs
- 4—Octal wafer sockets

Bottom view showing by-pass condensers and fixed resistors.

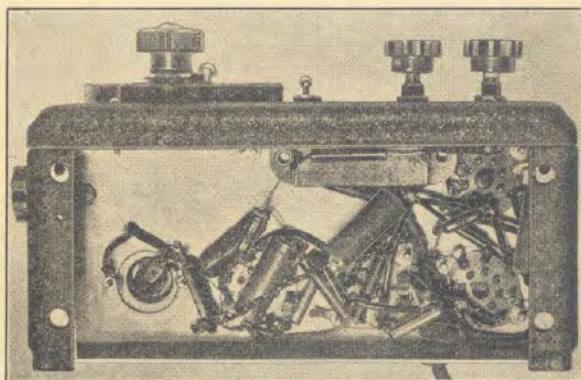

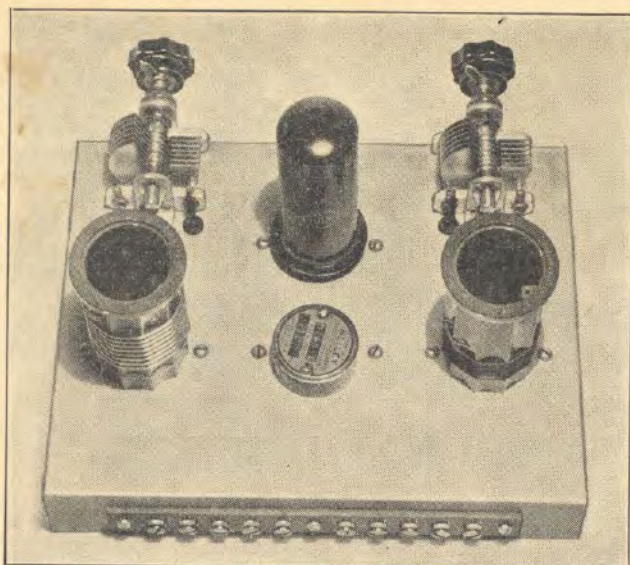

The one-tube 2-band transmitter for beginners.

6L6 Transmitter For Beginner

THIS transmitter was originally described in the 1938 edition of the Radio Amateur's Handbook published by the A.R.R.L. It was intended primarily for the beginner. The copy shown in the photograph was built in the Hammarlund laboratory and carefully tested.

The beginner starting out with a transmitter of this type will find it very convenient to add to it in order to complete a higher powered transmitter. Used by itself, it will provide a very efficient code transmitter, capable of operation on all bands from 175 to 20 meters. It consists of a 6L6 beam tube, "tri-tet" oscillator, and is crystal controlled. The transmitter will operate on two amateur bands with a single crystal. For instance, starting out with a 160 meter crystal, operation is possible on the 80 meter band as well as the 160 meter band. A tuned circuit is connected in the cathode lead, and the crystal connected between the grid and cathode. This tuned circuit consisting of L-1 and the 100 mmf. condenser, which tunes it, is adjusted to a frequency approximately midway between the crystal frequency and the second harmonic. This makes it

possible to tune the plate circuit, consisting of L-2 and its 100 mmf. tuning condenser, to twice the crystal frequency with very little decrease in power output.

Looking at the top view of the transmitter, we find that the cathode tuning control is on the left, just behind it is the cathode coil, L-1. The tube and the crystal are mounted in the center of the chassis and the plate circuit, consisting of the tuning condenser and L-2,

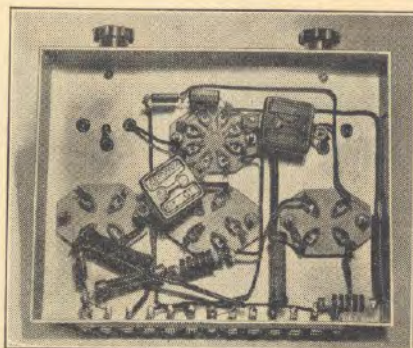

Fixed condensers and resistors are mounted underneath.

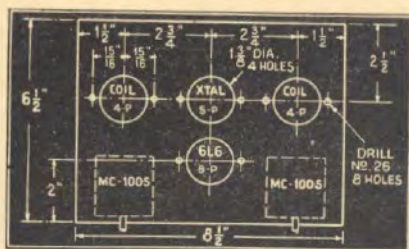

Completely drilled chassis for one-tube transmitter.

are on the right. Plug-in coils are wound on Hammarlund SWF 4-prong coil forms. Coil L-1 has 28 turns of No. 18 cotton covered wire, close wound, for a 1.75 mc. crystal. If a 3.5 mc. crystal is employed, 10 turns should be used and the 7 mc. coil has five turns. For 1.75 mc. L-2 has 60 turns of No. 24 cotton covered wire; for 3.5 mc. 30 turns of No. 28 cotton covered wire; 7 mc., 14 turns of the same wire; 14 mc., 8 turns of No. 18 cotton covered wire. These coils are all wound to a length of $1\frac{1}{2}$ " spaced, where required, to meet this length. The link coil, L-3, is wound on the same form with L-2 and consists of two or more turns depending upon the amount of coupling necessary.

The power output of this transmitter is approximately 15 watts with 400 volts applied to the plate of the 6L6 at a plate current of approximately 60 ma.

Two methods of coupling an antenna or another amplifier to this oscillator are provided. One consists of the link L-3 which should be used with twisted-pair feeders. A half-wave doublet em-

ploying twisted pair or similar type of feeder will work very nicely with this transmitter. If the single-wire fed antenna is employed, it may be coupled directly to terminal "A".

The cathode tuning condenser should be adjusted so that the crystal oscillates stably. Without the antenna connected, the plate tuning condenser should be adjusted for a minimum plate current, that is, when operated on the second harmonic. When the antenna is coupled to the plate coil, it will be necessary to re-adjust the plate condenser slightly for maximum output. Don't try to drain the last bit of power out of the oscillator, because it will not key smoothly.

Parts List

HAMMARLUND

- 2—MC-100-5 variable condensers
- 2—CH-X 2.1 mh. R.F. chokes
- 2—S-4 Isolantite sockets
- 1—S-5 Isolantite socket
- 1—S-3 Isolantite socket
- 7—SWF-4 prong, XP-53 coil forms

I. R. C.

(Resistors)

- 1—400 ohm 10 watt wire wound
- 1—25,000 ohm 10 watt wire wound
- 1—100,000 ohm 1 watt metalized

CORNELL DUBILIER

(Condensers)

- 1—.002 mf. mica receiving type
- 2—.01 mf. tubular, 400 V.
- 1—250 mmf. mica, 500 V.
- 1—50 mmf. mica, 500 V.

R. C. A.

- 1—6L6 Beam tube

MISC.

- 1—Chassis, $6\frac{1}{2}$ " x $8\frac{1}{2}$ " x $1\frac{1}{2}$ "
- 2—Knobs
- 1—Crystal

Complete wiring diagram and parts values for transmitter.

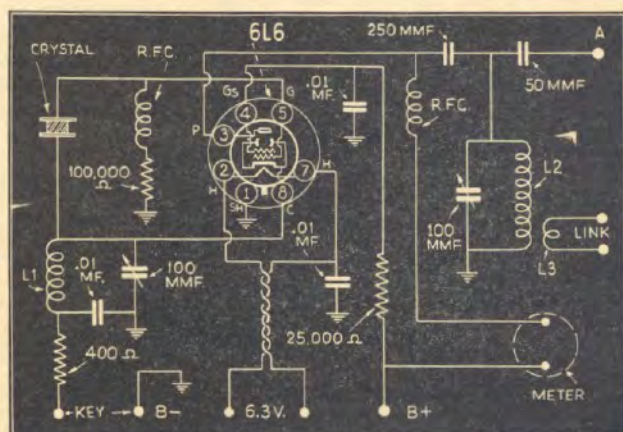

25-Watt Buffer- Doubler

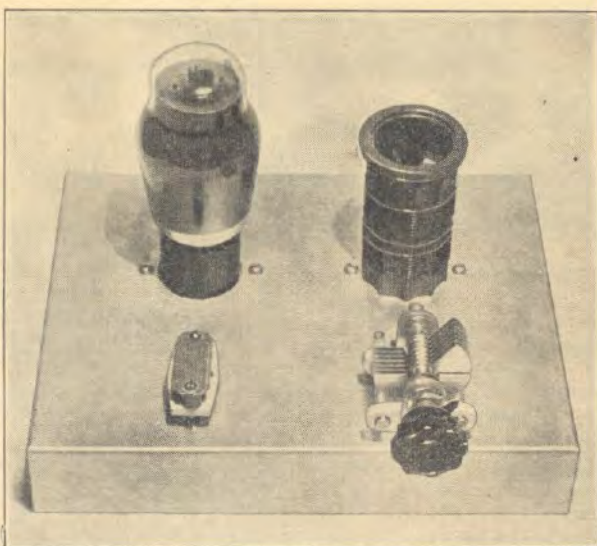

THIS 6L6 "Buffer-Doubler" is designed to be used with the Tri-Tet oscillator previously described. This unit, added to the Tri-Tet oscillator, constitutes a two stage transmitter capable of operation in three amateur bands with a single crystal. The glass variety of 6L6 is employed in the buffer stage instead of the metal 6L6 which is used in the oscillator. The glass tube provides slightly better performance at the same frequencies although it requires neutralizing. As can be seen, the circuit diagram for this stage is very simple; only one tuned circuit is required.

The amplifier is mounted on an aluminum base exactly the same size as that of the oscillator. The dimensions and drilling specifications are given in the accompanying drawing. The placement of parts is clearly shown in the photograph. On the left-hand side of the chassis we have the 6L6-G tube and directly in front of it, the special neutral-

izing condenser, which will be taken up in detail later. On the right-hand side, we find the center tapped coil and in front of it, the 100 mmf. tuning condenser. All wiring and by-pass condensers are beneath the chassis as can be seen in the bottom view. The terminal strip for making various connections is along the rear edge.

Returning to the neutralizing condenser, it consists of two small pieces of thin aluminum $1\frac{1}{8}$ " long and $\frac{1}{2}$ " wide. These are mounted on an insulating strip and the spacing between the two plates is approximately $\frac{1}{8}$ ". Adjustment is made by swinging the top plate or bending to increase the spacing between them until proper neutralization is obtained. No cathode bias is employed although a 400 ohm 10 watt resistor can be connected in series with the cathode as a precautionary measure against damage to the tube should the excitation be removed while the plate voltage is applied. This resistor should be by-passed with a .01 mf. condenser of good quality, preferably mica. Screen grid voltage is obtained directly from the B-plus lead of the power supply. A 15,000 ohm resistor limits the voltage to the proper value. In order to neutralize the 6L6 it is necessary to employ a split or center-tapped inductance. These coils are wound on 5-prong XP-53 plug in forms and tuned with a 100 mmf. MC-100-S midget condenser.

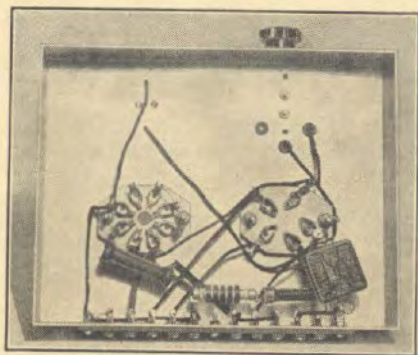

Coil data is as follows: The largest coil has 60 turns of No. 24 wire, close wound for 1.75 mc.; 34 turns of No. 28 is spaced to 1½" length for 3.5 mc.; 16 turns spaced to 1½" for 7 mc., same size wire; 10 turns No. 18 spaced to 1½" for 14 mc., and 6 turns of No. 18 same spacing, for 28 mc. The small coil between the two sections of the larger one (leave about 3/16" space in center of coil for the link) is the two turn link, two turns usually being sufficient for the right amount of coupling. The number of turns may be varied, however, to suit requirements. With an input of 400 volts, at approximately 100 milliamperes, the output is around 25 watts, making a real nice low powered transmitter. This stage may be operated as a straight amplifier, that is, the output circuit tuned to the same frequency as the oscillator or driver, or it may be tuned to twice this frequency. For instance, employing an 80 meter crystal in the oscillator with its plate circuit tuned to 40 meters, this amplifier may be coupled to it and tuned to 20 meters with nearly 25 watts output.

The first step in tuning the amplifier is neutralizing. The best arrangement for this is a small dial light connected to two turns of a wire approximately ½" larger in diameter than the coil, or, for that matter, the dial light can be connected to the two turn link. Then with the B-plus disconnected and the input terminal connected to the oscillator, adjust the 100 mmf. condenser until the dial light glows. It might be a good idea to swing the neutralizing condenser plates apart before attempting to neutralize the amplifier in order that you may be sure to obtain a glow in the bulb. Then push the plates of the neutralizing condenser closer together and

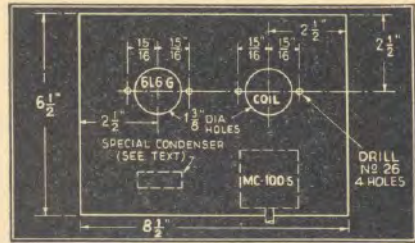

at the same time swing the plate tuning condenser back and forth through resonance. Continue this operation until the dial light does not glow when the plate circuit is tuned to resonance. With the doublet antenna connected to the amplifier, the plate current should be approximately 100 milliamperes. If the full load plate current is greater than 100 ma. it will be necessary to reduce the number of turns in the link coil. Since only link coupling is shown, a doublet antenna with twisted pair feeders must be used if this is intended for an output stage. For other type of antennas, it will be necessary to employ some sort of tuning network.

Parts List

HAMMARLUND

- 1—MC-100-S condenser
- 1—CH-X, 2.1 mh. R.F. Choke
- 1—S-8, Isolantite socket (8 prongs)
- 1—S-5, Isolantite socket (5 prongs)
- 4—SWF-5—5-prong coil forms

AEROVOX

- 2—.01 mf. mica condensers (500 V.)

I. R. C.

- 1—15,000 ohm 10 watt resistor
- 1—50,000 ohm 1 watt resistor

R. C. A.

- 1—6L6-G tube

MISC.

- 1—Chassis, 8-1/2" x 6-1/2" x 1-1/2" (1/16" aluminum)
- 1—Pointer knob

Wiring diagram of "Buffer-Doubler" for 3-stage transmitter.

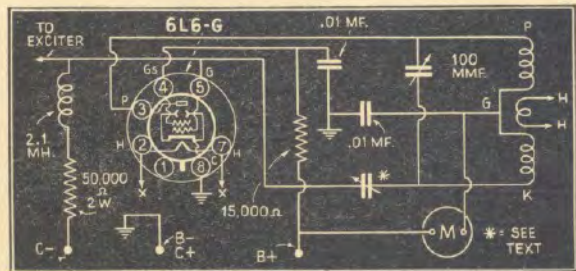

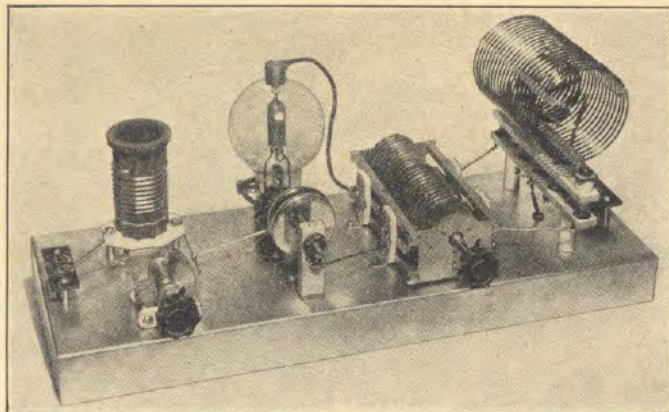

140-WATT FINAL AMPLIFIER

AFTER building the two transmitting units previously described, the experimenter will undoubtedly at some time or other desire greater power. This amplifier is capable of delivering approximately 140 watts of power and is designed to operate with the oscillator and buffer units already described. This unit, like the other two, is mounted on a metal chassis. Dimensions are 17" x 6" x 1½".

Starting from left to right, we have the plug-in grid coil with the "MC-100-S" tuning condenser in front of it. The 308 tube and the neutralizing condenser are located near the center of the chassis. Next, we have the "MTCD-100-B" variable condenser and finally the plug-in plate coil. The "CH-500" radio frequency choke coil is mounted underneath the

chassis. All connections, except where flexible leads are required, are made with No. 12 tinned copper wire.

This amplifier, as well as the two transmitting units, previously described, have been taken from the A.R.R.L. Handbook but were constructed in the Hammarlund laboratories and given careful tests.

The grid coil is wound on Hammarlund SWF-4 receiving coil form with the turns spaced to a length of 1½". The turns used for the various amateur bands are as follows: 1.75 mc., 50 turns No. 24 D.S.C.; 3.5 mc., 25 turns No. 22 D.S.C.; 7 mc., 15 turns No. 22 D.S.C.; 14 mc., 8 turns No. 28 enameled; 28 mc., 5 turns No. 18 enameled. The link coil consists of two turns wound at the C-minus end of the grid coil. The plate coils used

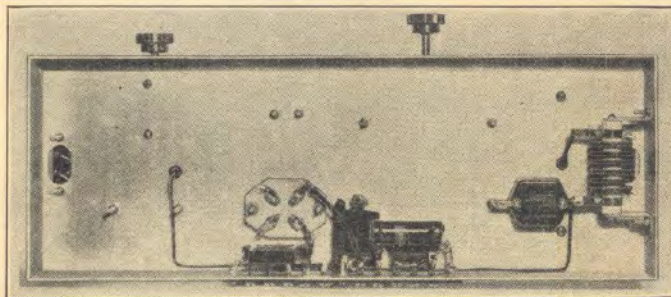

Bottom view showing placement of condensers, resistors, and R.F. choke.

Drilling specifications for amplifier chassis.

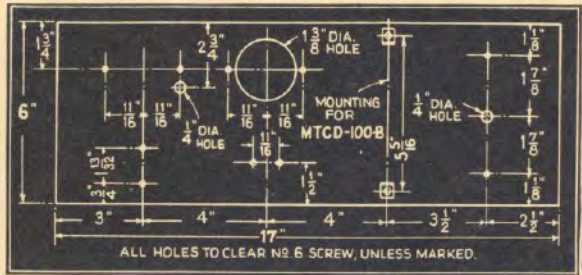

with this transmitter are standard Coto coils. However, data is given for those who may wish to construct their own: 1.75 mc., 70 turns No. 18; 3.5 mc., 34 turns No. 14; 7 mc., 22 turns No. 14; 14 mc., 10 turns No. 14; 28 mc., 6 turns No. 14. All coils are wound to a length of 4 inches with a diameter of 2 3/4 inches. The antenna is coupled by a link consisting of three or more turns wound inside the plate coil. Other methods of coupling of course may be used and depend to a great extent upon the antenna system employed.

Tuning and adjusting the amplifier is the same as in all other amplifiers of similar design. When coupled to the oscillator, the first operation is neutralizing. This is accomplished by connecting a 0-100MA. meter in the grid circuit of the 808. With the B-plus connection removed, adjust the grid tuning condenser for maximum grid current. Next, adjust the neutralizing condenser for widest spacing. Then rotate the plate tuning condenser slowly until a point is reached where there is a decided dip in grid current. Next, adjust the neutralizing condenser by moving the plates

Parts List

- HAMMARLUND
 1—MC-100-S midget cond.
 1—N-10 neutralizing cond.
 2—S-4, 4-prong sockets
 1—CH-500 R.F. choke coil
- I. R. C.
 1—3,500 ohm 10 watt resistor
- AEROVOX
 (cond.)
 2—.002 mf. mica 2500 volt
 1—.001 mf. mica 1,000 volt
 1—.001 mf. mica 5,000 volt
- COTO COIL
 1—Mounting Ease with coils to cover the bands desired.
- R. C. A.
 1—808 power tube.
- MISC.
 1—17" x 6" x 1 1/2" aluminum chassis
 2—Knobs
 2—2-point terminal strips
 2—5-point terminal strips

closer together and at the same time swing the plate condenser back and forth across the point where the dip occurred. Continue this procedure until no fluctuation in grid current is noticeable when the plate condenser is tuned through resonance. The plate condenser should be left at the setting where the dip occurred. Then, apply the plate voltage and adjust the plate condenser for minimum plate current. This should be around 15 or 20 ma. The antenna can now be coupled to the amplifier and it can be loaded to approximately 125 ma. If the power supply, described later on in this book, is employed the output will be approximately 110 watts. Up to 1500 volts may be employed with corresponding increase in output, the maximum being approximately 140 watts.

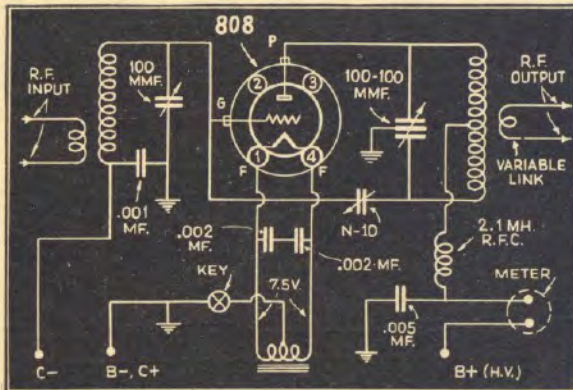

Transmitter Power Supplies

High Voltage Unit

THE power supply of any transmitter is the unit from which all power taken. The oscillator, amplifier or whatever type of R.F. unit is used in conjunction with the power supply merely converts the power taken from the power supply into high frequency currents. Therefore, the power supply is one of the most important parts of any transmitting set-up and deserves careful attention.

The high voltage power supply shown in the photograph is capable of delivering 1250 volts at 250 ma. to the final stage of the transmitter.

The secondary of the plate transformer is tapped to provide either 1000 or 1250 volts. When the final amplifier is used for phone transmission the 1000 volt tap on the power supply should be employed. For CW or code transmission, the full 1250 volts should be used for increased output. This power supply, while it does not include an abundance of filtering, will provide pure enough DC for the final amplifier. Actual tests have proved this.

Two 866's are employed in the recti-

fier circuit and they are followed by a choke input filter circuit consisting of a single swinging choke and one 2 mf. 2000 volt filter condenser. The filter choke is rated at 250 ma., the same as the transformer. The 50,000 ohm bleeder across the output of the power supply is employed to prevent surges and peaks which may be present while the transmitter is being keyed. The filament transformer for the rectifier tubes is rated at 2½ volts at 10 amperes and is insulated for 10,000 volts. The filament transformer for the power amplifier tube has an output of 7½ volts at

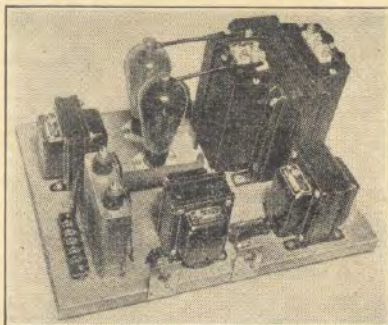

The high voltage power supply unit for use with the final amplifier of the 3-stage all-band ham transmitter.

Parts List

HAMMARLUND

- 2—S-4, 4-prong sockets
I. R. C.
 - 1—50,000 ohm 75 watt resistor
CORNELL-DUBILIER
 - 1—2mf., 2000 V. filter condenser
STANCOR
 - 1—2.5 V., 10 ampere filter trans.
No. P-3025
 - 1—7.5 V., 8 ampere filter trans.
No. P-4092
 - 1—1000-1250 V. plate transformer
No. P-5051
 - 1—Filter choke 8-30 H. 250 ma.
No. C-1402
- MISC.
- 2—Toggle switches
 - 1—Baseboard 16" x 11½" x 1".
R. C. A.
 - 2—866 tubes

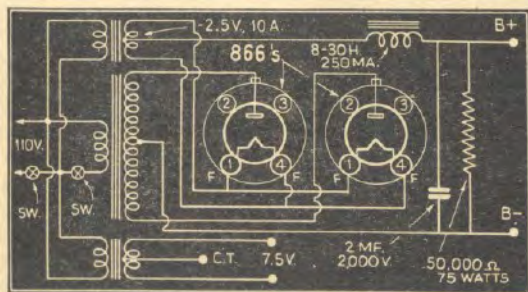

Wiring diagram and parts values for the high voltage power supply.

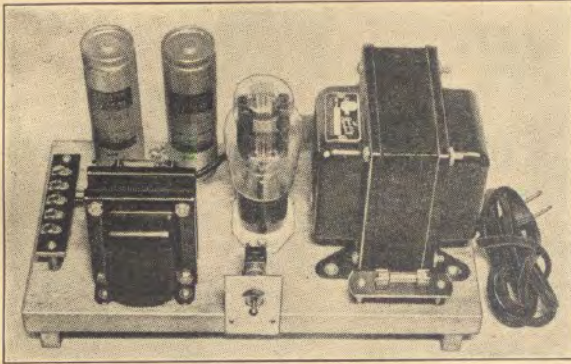

Low voltage power supply for the oscillator and buffer stages of the transmitter.

8 amperes. While the current rating of this transformer is greater than necessary for single 808, it permits the use of two 808's in push-pull.

Low Voltage Power Supply

It is possible to use a common power supply for the entire transmitter. However, much better results will be obtained if at least the low power stages are operated from one power supply and the high power stage from another separate power supply.

This power supply delivers 400 volts at 160 ma. and is designed for operating the 6L6 oscillator and buffer-doubler stages of the transmitter featured a few pages back. The large transformer employed delivers 400 volts each side of center tap at 160 ma. It also contains two filament windings. One 6.3 volt, 4.5 ampere winding for the 6L6's and another 5 volt 3 ampere winding for the 33V rectifier tube. Since this power supply is used for the oscillator where

better filtering is necessary, we employ condenser input. Two 8 mf. 500 volt condensers, connected on either side of a 20-henry filter choke provide absolutely pure DC as evidenced by the quality of the note from the transmitter when on the air. The bleeder for this power supply is a 20,000 ohm 50 watt wire wound resistor employed in order to stabilize the output. Only one switch is required in the primary circuit. This is for turning the 110 volt side on and off. An additional switch may be incor-

porated in the center tap lead of the high voltage winding, for turning this part of the circuit on and off.

Both power supplies are constructed on wood base boards. Each power supply has a fuse in the 110 volt line. These can be seen in the photograph although they are not shown in the diagram.

Parts List

HAMMARLUND

- 1—S-4, 4-prong socket
- I. R. C.
- 1—20,000 ohm, 50 watt resistor
- AEROVOX
- 2—8 mf. 500 V. electrolytic conds.
- STANCOR
- 1—Plate-fil. transformer No. P-4081
(see text for rating)
- 1—Filter choke 20 H. 175 ma.
No. C-1430

R. C. A.

- 1—83V tube

MISC.

- 1—Toggle switch
- 1—Baseboard 11½" x 6" x 1"

Wiring diagram showing the connection for the low voltage power supply unit.

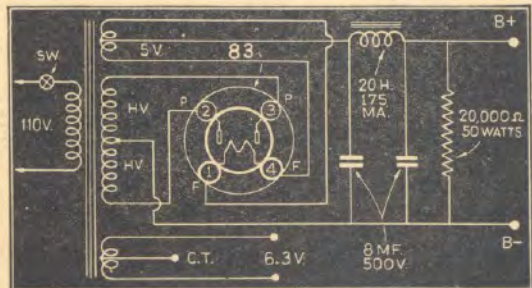

INDEX

Short Wave Station List	4
One Tube Battery Set	6
Metal Tube Two	8
Three Tube Band Spread Set	10
Two Stage Pre-Selector	12
Short Wave Converter	14
Receiver Power Supply	18
5-Meter MOPA	20
Five Meter Superhet	22
6L6 Transmitter	24
25-Watt Buffer	26
140 Watt Final Amplifier	28
Transmitter Power Supplies	30





75-907
78
10012